

Visual Observation of Entrained (Pick-up) velocity of Sand Particles Part I – low viscous fluid

Abstract:

Solids transport in oil and gas pipeline is organized under the Terminology of “flow assurance”. Although many industrial challenges are encountered concerning solids problems, they received little interest to date in the literature; this is especially true for solids transport in viscose fluid.

The complex flow behavior of sand is based on interaction between sand particles and carrier fluid; the interaction depends on different parameters, particle size is one of those parameters. Understanding the effects of these parameters on slurry viscosity is important to develop the slurry treating processes and predict slurry viscosity.

This study presented a visual observation of the entrained velocity which requires initiating the movement of solid particles (bed) into the low viscous fluid (water). The tests were carried out by observing the movement of the bed particles in the transparent horizontal pipe while the water velocity changed from low to high value. The definition of the entrained velocity is the change of the sand bed status from stationary sand bed to moving sand bed. The carrier fluid was water; the entrained velocities of the sand bed with different particles concentrations were measured as well as pressure gradient.

The results showed that entrained velocity increases as the sand grain size decreases and higher sand concentration.

Introduction:

Flow assurance governs the success of the fluid journey from reservoir to point of sale. Multiphase flow, hydrates, emulsions, wax, scale, corrosion and sand production are typical troublemakers for flow assurance. Unlike issues such as waxes and hydrates, Solids problems have received relatively little interest to date; this is especially true for solids transport in high-viscosity oils.

The operators are possible to face technical issues during crude oil production from a reservoir. There are three technical issues that are critical to sand production for oil and gas operating companies, which are needed to maximize reservoir production while maintaining the integrity of the production facility under conditions of sand production, namely sand erosion due to high velocity, sand settling due to low velocity, and sand monitoring. Flow regimes for solids transport can be classified according to solid/liquid and solid/liquid/gas systems. In this paper we are focused on solid/liquid flow regimes in the pipeline.

The complex flow behavior of sand is based on interaction between sand particles and carrier fluid; the interaction depends on different parameters, particle size is one of those parameters. Understanding the effects of these parameters on slurry viscosity is important to develop the slurry treating processes and predict slurry viscosity.

There are two seniors of sand phenomena in the pipe; settling problems occur when the slurry velocity decrease from high to low value which causes the sand deposition phenomena. Pick-up velocity is the velocity required to Pick-up particles from rest (Kimberly et al 2003), it can be defined as the required velocity to move the sand bed from the stationary sand bed to moving sand bed (Ramadan et al 2003), different behaviour of sand can be observed for the sand phenomenon like Stationary bed, moving sand bed, Saltaion, Scouring, Moving dunes Dispersed (Sze-Foo Chien, 1994). Sand entrained velocity correlations has been created by many researchers.

Bain and Bonnington (1970) proposed the following correlation for the critical transition velocity from stationary bed to moving bed

$$V_c = 3.4 C \frac{1}{3} \left[\frac{gD (S - 1)}{\sqrt{C_d}} \right]^{\frac{1}{2}}$$

By differentiating Durand’s pressure loss equation Shook (1969) developed a correlation for the critical transition velocity from stationary bed to moving bed

$$V_c = \frac{2.48 C^{\frac{1}{3}}}{Cd^{\frac{1}{4}}} [2gD(S - 1)]^{0.5}$$

Schulz (1962) conducted a series of tests with coal and gravel of particle and proposed a correlation for the critical transition velocity from moving bed to suspension as following

$$V_c = 2.232 \sqrt{gD(S - 1)^{1.5}}$$

Newitt et al (1955) conducted experiments with particle size less than 30 micron in 1 inch diameter pipe and proposed the following correlation for the critical transition velocity from moving bed to suspension

$$V_c = 12.165(gDV_s)^{\frac{1}{3}}$$

Work Objective:

The aim of this study is to present a visual observation of the entrained velocity of different sand concentration in water as low viscous fluid using 1-inch horizontal pipeline. The pressure Gradient and estimation of entrained velocity were measured and studied respectively.

Experimental Setup:

Sand Transportation Facility (1-inch) was constructed at Cranfield University. The facility was used to study the sand behaviour and sand transportation in a horizontal configuration. Different systems have been studied using the facility, including two-phase air/water with and without sand, and three-phase air/water/oil with and without sand. Flow pattern, sand behaviour, Pressure gradient and settling / Pick-up velocities were determined and recorded from visual records. The simplified P&ID diagram is shown in Figure 1. The pick-up velocity is defined as the velocity required to wash out the sand bed in a pipe within one minute. Sand particle behavior was visually observed and recorded using a camera in addition to the pressure gradient was obtained and examined at different velocities. The experiments were performed using sand with a density of 2650 kg/m³ and a median diameter of 147 μ (0.147 mm).

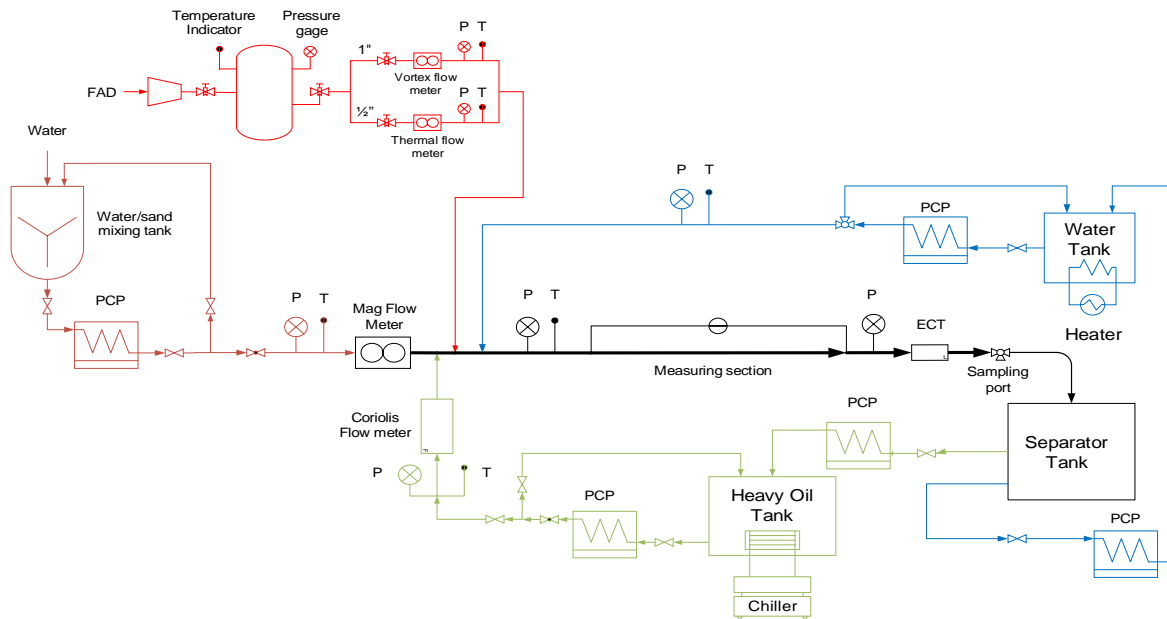
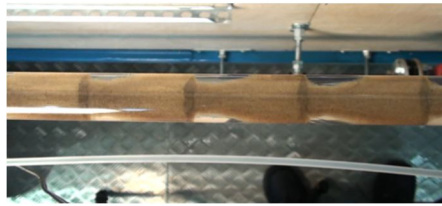

Figure 1 Simplified P&ID diagram of 1 inch heavy oil test facility

- **Sand behavior observation**

At $V_1 = 0.19$ m/s, a few sand particles began to move from the top of the sand bed for the low velocities for sand concentration 1%. As it was increased the layers began to be removed until it reached the bottom of the pipe where all the sand was washed out.

The forming of sand dunes were observed in the pipe as shown in Figure 2. However, as the velocity was increased to 0.31 m/s, the length and size of the dunes amplified (Figure 3). Increment of the velocity led to dissolving the dunes structure into sand streaks (Figure 4).



Top view

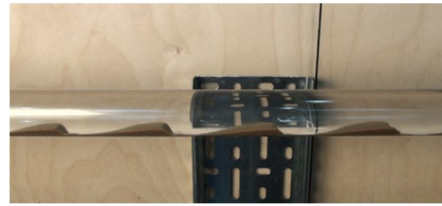

Side view

Figure 2 Moving sand dunes for 1% sand at $V_1 = 0.19$ m/s



Top view

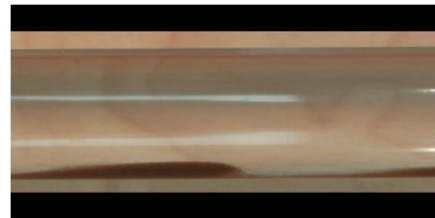

Side view

Figure 3 Moving sand dunes for 1% sand at $V_1 = 0.31$ m/s flow

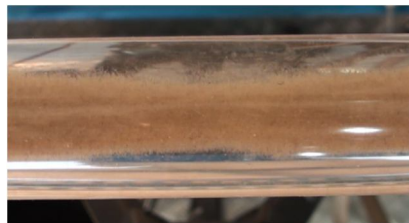

Large connected sand dunes ($V_1 = 0.40$ m/s)

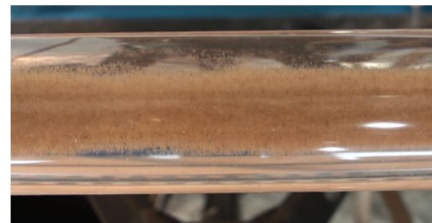

Moving Sand layer ($V_1 = 0.48$ m/s)

Figure 4 Sand dunes becomes sand streaks for 1% sand (top view)

The pick-up velocity was achieved at $V_1 = 0.57$ m/s where the sand layer was washed out as (figure 5).



Sand bed (time = 1 sec)



Pick-up velocity (time = 22 sec)

Figure 5 Pick-up velocity reached at $V_1 = 0.57$ m/s for 1% sand (bottom view)

An attempt to observe any different washout pattern was done at $V_1 = 1.3$ m/s. Yet similar behavior was detected when reviewing the video recording. An increase of the velocity will only lead to a faster pace of the same mechanism, which is washing the sand particles layer-by-layer until the last layer on the bottom of the pipe is washed. For this attempt, the sand was flushed in 4 seconds only (Figure 6).

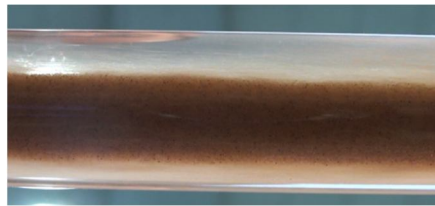

Sand bed (time = 1 sec)



Sand flushed (time = 4 sec)

Figure 6 Flush attempt at $V_1 = 1.30$ m/s for 1% sand (bottom view)

The sand concentration was increased to 5% by volume, only few sand particles began to move from the top of the sand bed for the low velocities. However, unlike the 1% sand findings, the forming of sand dunes was not observed in the pipe at $V_1 = 0.19$ m/s as shown in Figure 7. However, as the velocity was increased to 0.28 m/s, very large sand dunes began to formulate (Figure 8).

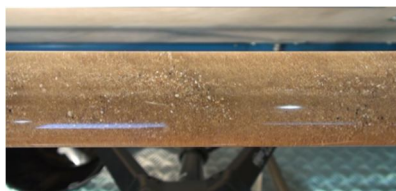

Top view



Side view

Figure 7 Stationary bed for 5% sand at $V_1 = 0.19$ m/s



Top view



Side view

Figure 8 Large moving sand dunes for 5% sand at $V_1 = 0.28$ m/s

Further increment of the velocity led to dissolving the large dunes structure into sand bed (Figure 9). The pick-up velocity was achieved at $V_1 = 0.58$ m/s where the sand layer was washed out in 45 seconds (Figure 10). It took twice the time to wash out the sand bed due to its thickness as this concentration (5%) made a thicker sand layer when compared to 1% sand concentration by volume. As shown in Figure 11.



Large connected sand dunes ($V_1 = 0.39$ m/s)



Moving Sand layer ($V_1 = 0.49$ m/s)

Figure 9 Sand dunes becomes sand bed for 5% sand (top view)

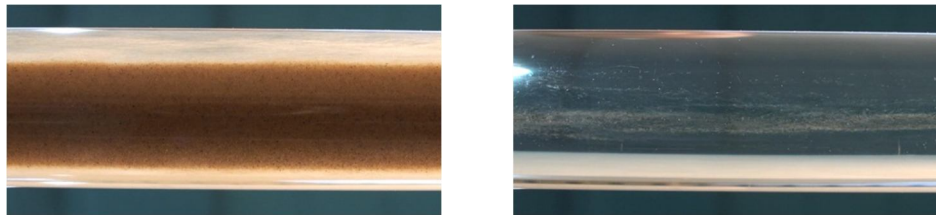

Sand bed (time = 1 sec)

Pick-up velocity (time = 45 sec)

Figure 10: Pick-up velocity reached at $V_1 = 0.58$ m/s for 5% sand (bottom view)

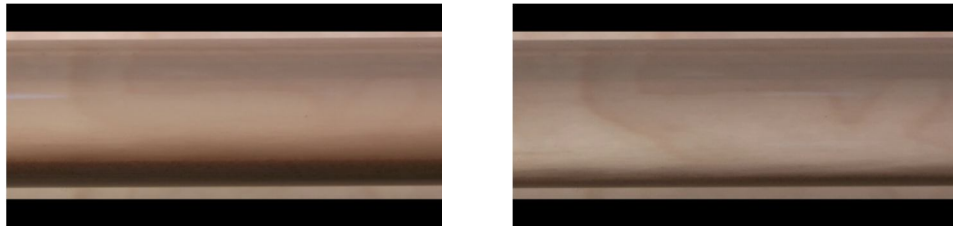

Sand layer (time = 1 sec)

Pick-up velocity (time = 45 sec)

Figure 11: Pick-up velocity reached at $V_1 = 0.58$ m/s for 5% sand (side view)

It's been observed that the layers of sand began to wash at 0.58 m/s, yet our defined criteria was not met as it required more than one minute to completely remove the sand bed at this velocity. Therefore the velocity was increased and the pick-up velocity was achieved at $V_1 = 0.70$ m/s where the sand layer was washed out in 36 seconds (Figure 12). The lower velocities weren't examined where only few sand particles began to move from the top of the sand bed.

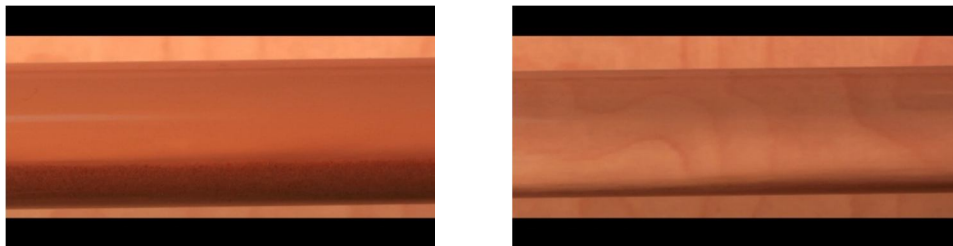

Sand layer (time = 1 sec)

Pick-up velocity (time = 36 sec)

Figure 12: Pick-up velocity reached at $V_1 = 0.70$ m/s for 10% sand concentration by volume (side view)

- **Pressure gradient measurement**

The pressure gradient was obtained for many liquid velocities ranging from 0.2 m/s to 1.2 m/s and examined against 4 different correlations (Darcy, Swamee Jain, Haaland, and Chen) as shown in Figure 13. The results from the comparison showed a good agreement with the measured values. Therefore, the same correlations were chosen to substitute the measured data sets for further investigations. The liquid used was tap water with a density of 1000 kg/m^3 and a viscosity of 1.003 cP.

The pressure gradient for different sand concentration was obtained and examined at different velocities. Figure 14 shows a comparison of the pressure gradient between the two phase test (water/sand) and the single phase (water) for 1%, 5% and 10 % sand concentration by volume. For 1 % sand it's noted that the differences were big at low velocities, due to the presence of sand bed. However the differences started to decrease as the flow rate became higher owing to the breakage of the sand bed. The pressure gradient for 5% sand concentration. Showed similar behaviour to the 1% sand concentration findings, the differences were big at low velocities, due to the presence of sand bed. However the differences started to decrease as the flow

rate became higher owing to the breakage of the sand bed. For 10% sand concentration by volume. Aside from the result at the pick-up velocity, the pressure gradient for the mixture was higher than single phase due to the presence of sand bed layer in the pipe. However at 0.70 m/s, the washing mechanism was in affect for 36 seconds, while the pressure gradient recording was for a full 60 seconds (for consistency); this led to washing the sand layer from one tap while the other tap is covered by the sand for some time, and the consequence is having lower pressure difference for the slurry mixture than water alone.

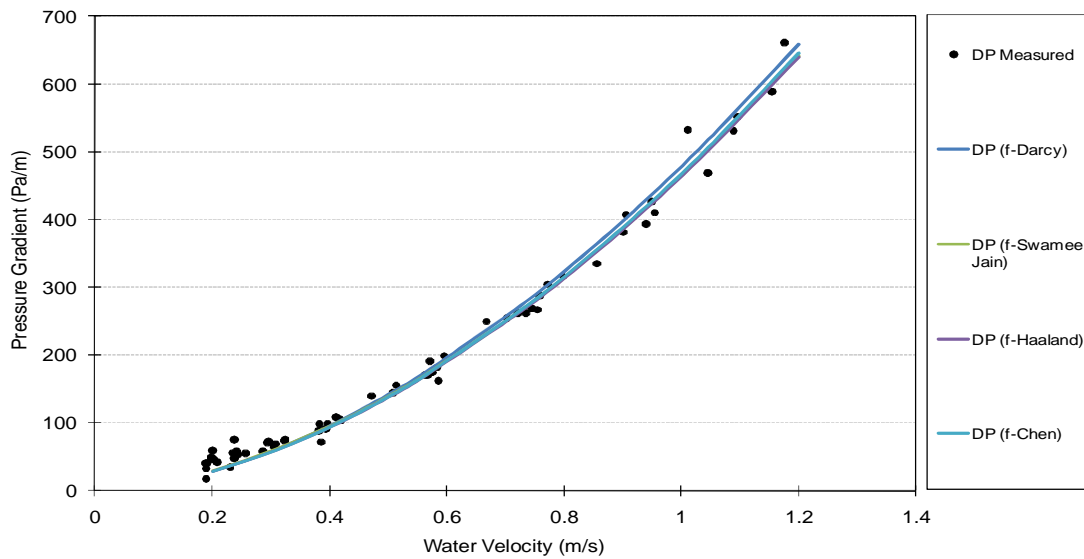

Figure 13: Pressure gradient comparison between experimental results and different correlations

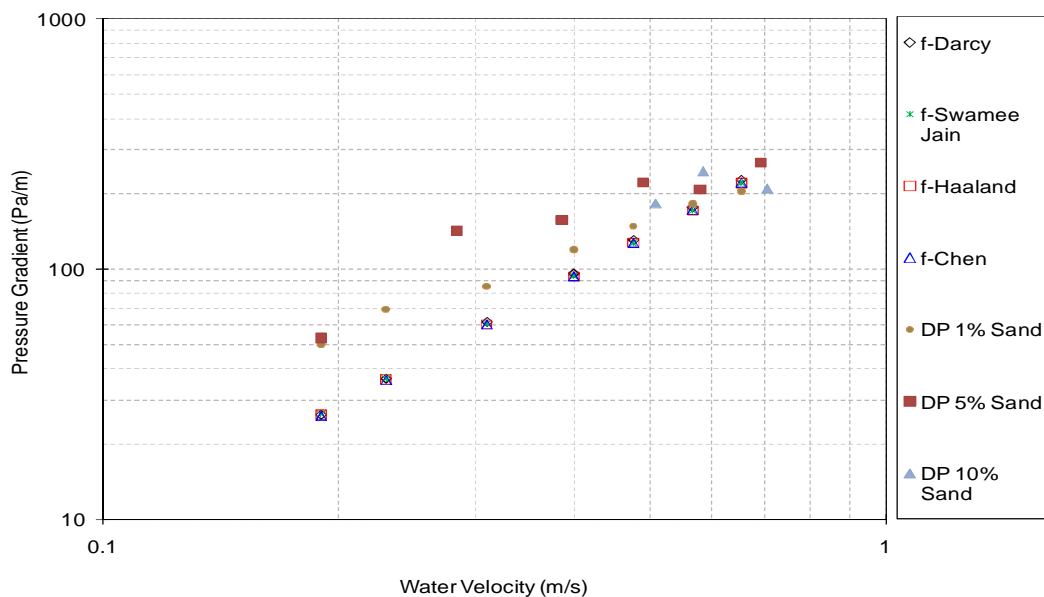

Figure 14 Pressure drop gradient of water/sand for 1%, 5%, and 10% sand concentration

Table 1 shows the comparison of different pressure gradients for different sand concentrations at the pick-up velocities and single phase flow. It's clearly shown that only for the highest examined sand volume fraction (10%) had any significant difference when comparing the pressure drop to the single (water) phase.

Table 1 Comparison of different pressure gradients for different sand concentrations at the pick-up velocities

Sand Vol. fraction	$V_{\text{entrained}}$ (m/s)	dp/dx (Pa/m) (Water/sand)	dp/dx (Pa/m) (Water only)
1%	0.57	183	177.3
5%	0.58	208.3	184.3
10%	0.70	209.8	260

- **Estimation of Pick-up velocity**

Pick-up velocity has been estimated using different correlations for liquid/solid systems in pipelines as created by many researchers. The prediction of the velocity is treated using correlations of experimental data some of which could be applied to all flow behavior, the others limited to particular flow behaviour. The entrained velocity has been defined by different investigators with different definitions, Table 2 shows the comparison of Pick-up velocity which has been estimated using different correlations for liquid/solid systems in pipelines as created by many researchers.

Table 2 Pick-up velocity estimation for horizontal 1-inch pipeline

Sand Loading (V %)	1	5	10
$V_{\text{Entrained}}$ (m/sec)	0.57	0.58	0.7
Correlation	Predicted velocity (m/sec)		
Wicks (1971)	0.55	0.55	0.55
Wasp et al(1977)	0.49	0.69	0.80
Babcok(1968)	0.12	0.27	0.38
Zandi(1967)	0.24	0.54	0.76
Shook(1969)	0.24	0.54	0.76
Bain&Bonnington(1970)	0.29	0.49	0.62
Oroskar and Turian (1980)	0.25	0.55	0.72
Newitt (1955)	0.63	0.63	0.63
Schulz(1962)	1.45	1.45	1.45
Iarsn(1968)	0.51	0.76	0.90

It can be seen from Table 2 that the predicted velocity is not same in value; this is due to the correlation created by experimental data which is restricted to the parameter limits as mentioned in the previous sections. Wicks' and Newitt's correlations did not consider the sand loading parameter. The Schulz model is over prediction while the others range from accepted value to poor estimation.

Conclusion:

- Pick-up experiments were performed for water/sand to study the behavior of sand particles under different conditions of water velocity. The investigations were conducted using the Cranfield University 1-inch. To achieve the above-

mentioned aim, pressure gradient and sand behavior observations were done. The sand used in the experiment had a density of 2650 kg/m³ and a median diameter of (0.147 mm).

- The sand particles' behaviors were visually observed in water flows, and the sand entrained velocity were obtained for different sand concentrations (1, 5, and 10% by volume).
- Sand particles began to move from the top of the sand bed for the low velocities, the forming of sand dunes were observed in the pipe as the velocity was increased, Increment of the velocity led to dissolving the dunes structure into sand streaks. For 5% sand the forming of sand dunes was observed in the pipe at velocity above the 1% sand. However, as the velocity was increased very large sand dunes began to formulate. The lower velocities weren't examined where only few sand particles began to move from the top of the sand bed. Pick-up velocities were 0.57 m/s, 0.58 m/s, and 0.70 m/s for 1, 5, and 10% by volume.
- The pressure gradients of single water flowing in the pipe have been recorded and compared with the existing correlation. It has been concluded that the correlation gives a good predictable value compared with the experimental value, the pressure gradient for different sand concentration was obtained and examined, and the differences were big at low velocities, due to the presence of sand bed. However the differences started to decrease as the flow rate became higher owing to
- Several correlations have been tested to estimate the entrained velocity at different conditions; most of the correlations showed different value, the reason that correlations have been created for certain conditions and have their limitations.

Reference:

1. Al-lababidi, S., Yan, W., Yeung, H., Sugarman, P. and Fairhurst, C.P, (2008), Sand Transport Characteristics in Water and Two-Phase Air/Water Flows in Pipelines, The 6th North American Conference on Multiphase Technology '08, June 2008.
2. Doron, P. and Barnea, D. (1996), Flow pattern maps for solid-liquid flow in pipes, *Int.J. Multiphase Flow* 22(2), pp. 273-283.
3. Dukler, A.E., Wicks, M. and Cleveland, R.G. (1964), Frictional Pressure Drop in Two-Phase Flow: A Comparison of Existing Correlations for Pressure Loss and Holdup, *AIChEJ*, 10, p. 38.
4. Durand, R. (1953), Basic Relationships of the Transportation of Solids in Pipes Experimental Research, Proceedings of Minnesota International Hydraulics Convention, pp. 89-103.
5. Friedel, L. (1979), Improved Friction Drop Correlations for Horizontal and Vertical Two-Phase Pipe Flow, European Two-Phase Flow Group Meeting, paper E2, Ispra, Italy.
6. Newitt, D.M., Richardson, J.F., Abbott, M. and Turtle, R.B. (1955), Hydraulic Conveying of Solids in Horizontal Pipes, *Trans. Inst. Chem. Eng.*, 33(2), pp. 93-113.
7. Oroskar, A.R., and Turian, R.M. (1980), "The Critical Velocity in Pipeline Flow of Slurries, *AIChE Journal*, 26, pp. 550-558.
8. Shook, C.A., Schriek, W., Smith, L.G., and Husband, W.H.W, (1973), Experimental Studies of the Transport of Sands in Liquids of Varying Properties in 2- and 4-inch Pipelines. Report E73-20, Saskatchewan Research Council, Saskatoon, Sask., Canada.
9. Zandi, I., Haydon, J.A. (1971), A Pneumo Slurry System of Collecting and Removing Solids Waste, In Zandi, I. (Ed.), *Advances in Solid-Liquid Flow in Pipes and its Applications*, Pergamon Press.

Authors & Affiliation

E. Zorgani¹, H. Al-Awadi², W. Yan³, and H. Yeung³

¹Libyan Petroleum Institute, Tripoli, Libya

²College of Technological Studies, Public Authority for Applied Education and Training, Kuwait

³Cranfield University, UK